

Visit [nipponpulse.com](http://nipponpulse.com) to download 3D CAD drawings and 2D prints of this motor.

Electrical Specs	S200D		S200T		S200Q		
	S200D	S200D 1S	S200T	S200T 1S	S200Q	S200Q 2S	S200Q 1S
Continuous Force <sup>1</sup>	18N (4.05lbs)		28N (6.29lbs)		38N (8.54lbs)		
Continuous Current <sup>1</sup>	0.59Arms	1.2Arms	0.59 Arms	1.8Arms	0.59Arms	1.2Amps	2.4Amps
Acceleration Force <sup>2</sup>	72N (16.2lbs)		112N (25.2lbs)		152N (34.2lbs)		
Acceleration Current <sup>2</sup>	2.4Arms	4.7Arms	2.4Arms	7.1Arms	2.4Arms	4.7Arms	9.4Arms
Force Constant (K <sub>f</sub> )	31N/Arms (6.86lbs/amp)	15N/Arms (3.32lbs/amp)	47N/Arms (10.67lbs/amp)	16N/Arms (3.63lbs/amp)	64N/Arms (14.48lbs/amp)	32N/Arms (7.24lbs/amp)	16N/Arms (3.62lbs/amp)
Back EMF (K <sub>e</sub> )	10V/m/s (0.26V/in/s)	5.1V/m/s (0.13V/in/s)	16V/m/s (0.4V/in/s)	5.3V/m/s (0.13V/in/s)	21V/m/s (0.55V/in/s)	11V/m/s (0.29V/in/s)	5.4V/m/s (0.14V/in/s)
Resistance 25°C <sup>3</sup>	29Ω	7.2Ω	43Ω	4.8Ω	56Ω	14Ω	3.5Ω
Inductance <sup>3</sup>	19mH	4.8mH	29mH	3.2mH	39mH	10mH	2.4mH
Electric Time Constant	0.67ms				0.70ms		
Max. Rated Voltage (AC)	240V						
Fundamental Motor Constant (K <sub>m</sub> )	5.70N√W		7.24N√W		8.61N√W		
Magnetic Pitch (North-North)	72mm (2.83in)						

Is this the proper Linear Shaft Motor for your application? Use our [SMART sizing program](#) to assist in your decision.

This motor can be customized to fit your application demands; contact your application engineer for more information.

<sup>1</sup> Based on a temp rise of coil surface of 110°K over 25°C ambient temperature stalled forcer, and no external cooling or heat sinking.

<sup>2</sup> Can be maintained for a maximum of 40 seconds. Higher forces and current possible for short periods of time, contact Nippon Pulse for more information.

<sup>3</sup> All winding parameters listed are measured line-to-line (phase-to-phase).

Thermal Specs	S200D	S200T	S200Q
Max Phase Temperature <sup>4</sup>	135°C (275°F)		
Thermal Resistance (Coil) (K <sub>c</sub> )	11°C/W (52°F/W)	7.3°C/W (45°F/W)	5.6°C/W (42°F/W)

<sup>4</sup> The standard temperature difference between the coil and the forcer surface is 20°C.

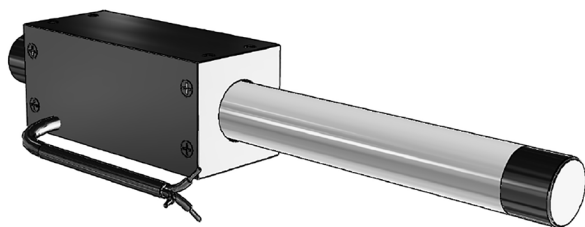

### Bus Voltage

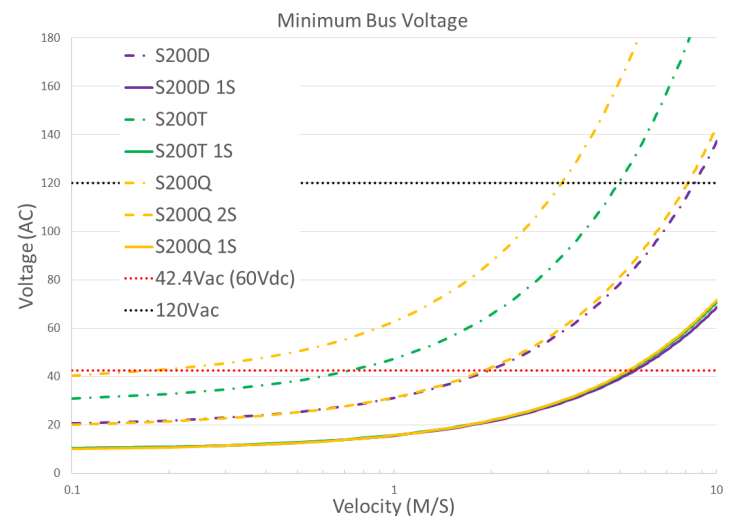

### Part Numbering System

S	—	Shaft Size 200	—	Forcer Size (A) <u>X</u>	—	Parallel Option <u>XX</u>	—	Usable Stroke (S) <u>XXXXst</u>	—	Options <u>XX</u>	—	Options <u>XX</u>
				D: Double (2) windings T: Triple (3) windings Q: Quadruple (4) windings		Blank: Single Motor PL: Parallel Motors		100-2000mm		Blank: Standard WP: Water Resistant HA: Digital Hall Effect CE: CE type motor FG: Frame Ground		Blank: Standard FO: Forcer Only SO: Shaft Only

Forcer Specs	S200D	S200T	S200Q
Forcer Length (A)	94mm (3.7in)	130mm (5.12in)	166mm (6.54in)
Forcer Width	40mm (1.57in)		
Forcer Screw Pitch (P)	84mm (3.31in)	120mm (4.72in)	156mm (6.14in)
Forcer Weight	0.30kg (0.66lbs)	0.50kg (1.1lbs)	0.70kg (1.54lbs)
Gap	0.75mm (0.03in)		

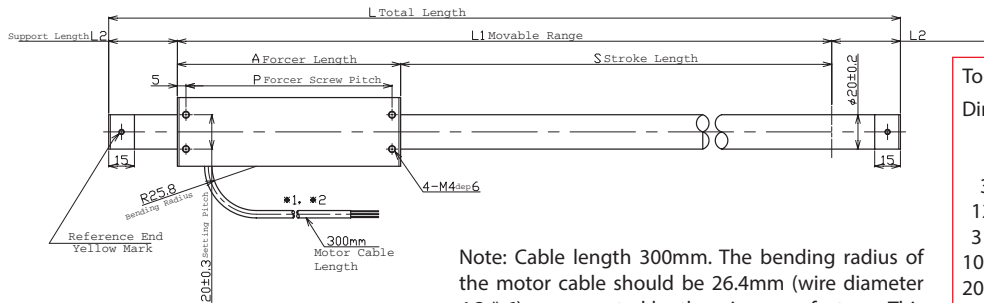

Tolerances are as follows:

Dimension (mm)	Tolerance (mm)
0 - 6	±0.1
7 - 30	±0.2
31 - 120	±0.3
121 - 315	±0.5
316 - 1000	±0.8
1001 - 2000	±1.2
2000 -	±1.5

L = See Shaft Length  
L1 = Usable Stroke + A  
L2 = See Support Length  
A = See Forcer Length  
P = See Forcer Screw Pitch

*Unless otherwise specified, dimensions are in mm*

Note: Cable length 300mm. The bending radius of the motor cable should be 26.4mm (wire diameter 4.3 \* 6) as suggested by the wire manufacturer. This radius should be maintained. Use supplied connector to attach the proper high-flex cable as required by your application.

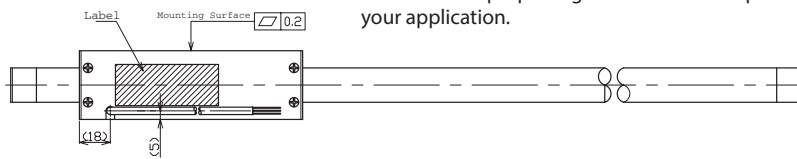
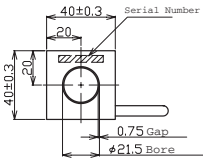

### Hall Effect Specs

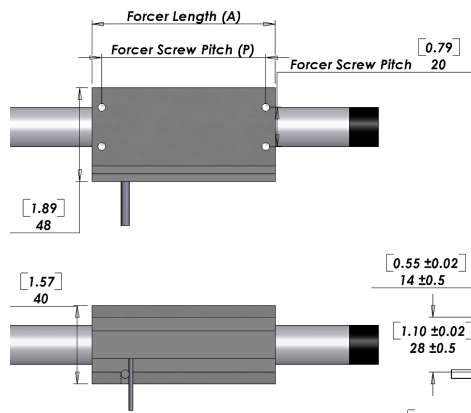

Note: The bending radius of the motor cable should be R26.4mm (wire diameter 4.6 \* 6) as suggested by the wire manufacturer. This radius should be maintained. Use supplied connector to attach the proper high-flex cable as required by your application.

### Sensor Cable Specs

Wire Type	UL 758
Wire AWG	28
VCC	White/Red
GND	White/Black
Sensor 1	Orange/Red
Sensor 2	Orange/Black
Sensor 3	Gray/Red

The bending radius of the sensor cable should be R27.6mm (wire diameter 4.4 \* 6) as suggested by the wire manufacturer. This radius should be maintained. Attach the proper high-flex cable as required by your application.

### FG/FGA Type Motor Cable

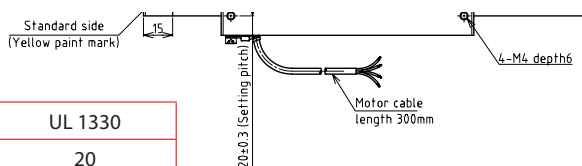

Wire Type	UL 1330
Wire AWG	20
Frame Ground	Green/Yellow

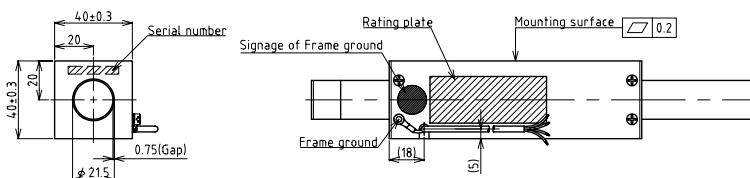

### Standard Lead Wire

Wire Type	UL 2464FA
Wire AWG	25
U Phase	Red
V Phase	White
W Phase	Black

300mm lead wire bare leads. The bending radius of the motor cable should be 26.4mm as suggested by the wire manufacturer.

### FGA/CE Lead Wire Option

Ground Wire	CE
Wire Type	UL 1330
Wire AWG	24
U Phase	Red
V Phase	White
W Phase	Black

300mm lead wire bare leads. The bending radius of the motor cable should be 16.96mm as suggested by the wire manufacturer. FG type with insulating sheet between coils and case. Meets all requirements of EN60034-1 (1998).

## Shaft Length (L)

Stroke	S200D	S200T	S200Q
100	244mm (9.6in)	280mm (11in)	316 (12.4in)
150	294mm (11.6in)	330mm (13in)	366mm (14.4in)
200	344mm (13.5in)	380 (15in)	416mm (16.4in)
250	394mm (15.5in)	430mm (16.9in)	466mm (18.3in)
300	444mm (17.5in)	480mm (18.9in)	516mm (20.3in)
350	524mm (20.6in)	560mm (22in)	596mm (23.5in)
400	574mm (22.6in)	610mm (24in)	646mm (25.4in)
450	624mm (24.6in)	660mm (26in)	696mm (27.4in)
500	674mm (26.5in)	710mm (28in)	746mm (29.4in)
550	724mm (28.5in)	760mm (29.9in)	796mm (31.3in)
600	774mm (30.5in)	810mm (31.9in)	846mm (33.3in)
650	824mm (32.4in)	860mm (33.9in)	896mm (35.3in)
700	874mm (34.4in)	910mm (35.8in)	946mm (37.2in)
750	964mm (38in)	1000mm (39.4in)	1036mm (40.8in)
800	1014mm (39.9in)	1050mm (41.3in)	1086mm (42.8in)
850	1064mm (41.9in)	1100mm (43.3in)	1136mm (44.7in)
900	1114mm (43.9in)	1150mm (45.3in)	1186mm (46.7in)
950	1164mm (45.8in)	1200mm (47.2in)	1236mm (48.7in)
1000	1214mm (47.8in)	1250mm (49.2in)	1286mm (50.6in)
1050	1264mm (49.8in)	1300mm (51.2in)	1336mm (52.6in)
1100	1314mm (51.7in)	1350mm (53.1in)	1386mm (54.6in)
1150	1364mm (53.7in)	1400mm (55.1in)	1436mm (56.5in)
1200	1414mm (55.7in)	1450mm (57.1in)	1486mm (58.5in)
1250	1464mm (57.6in)	1500mm (59.1in)	1536mm (60.5in)
1300	1514mm (59.6 in)	1550mm (61in)	1586mm (62.4in)
1350	1564mm (61.6in)	1600mm (63in)	1636mm (64.4in)
1400	1614mm (63.5in)	1650mm (65in)	1686mm (66.4in)
1450	1664mm (65.5in)	1700mm (66.9in)	1736mm (68.3in)
1500	1714mm (67.5in)	1750mm (68.9in)	1786mm (70.3in)
1550	1764mm (69.4in)	1800mm (70.9in)	1836mm (72.3in)

## Shaft Mass

Stroke	S200D	S200T	S200Q
100	0.5kg (1lb)	0.6kg (1.2lb)	0.6kg (1.4lb)
150	0.6kg (1.3lb)	0.7kg (1.5lb)	0.7kg (1.6lb)
200	0.7kg (1.5lb)	0.8kg (1.7lb)	0.9kg (1.9lb)
250	0.8kg (1.8lb)	0.9kg (1.9lb)	1kg (2.1lb)
300	0.9kg (2lb)	1kg (2.2lb)	1.1kg (2.4lb)
350	1.1kg (2.3lb)	1.1kg (2.5lb)	1.2kg (2.7lb)
400	1.2kg (2.6lb)	1.2kg (2.7lb)	1.3kg (2.9lb)
450	1.3kg (2.8lb)	1.4kg (3lb)	1.4kg (3.2lb)
500	1.4kg (3lb)	1.5kg (3.2lb)	1.5kg (3.4lb)
550	1.5kg (3.3lb)	1.6kg (3.5lb)	1.6kg (3.6lb)
600	1.6kg (3.5lb)	1.7kg (3.7lb)	1.8kg (3.9lb)
650	1.7kg (3.8lb)	1.8kg (3.9lb)	1.9kg (4.1lb)
700	1.8kg (4lb)	1.9kg (4.2lb)	2kg (4.4lb)
750	2kg (4.3lb)	2kg (4.5lb)	2.1kg (4.7lb)
800	2.1kg (4.6lb)	2.2kg (4.8lb)	2.2kg (4.9lb)
850	2.2kg (4.8lb)	2.3kg (5lb)	2.3kg (5.2lb)
900	2.3kg (5.1lb)	2.4kg (5.2lb)	2.5kg (5.4lb)
950	2.4kg (5.3lb)	2.5kg (5.5lb)	2.6kg (5.7lb)
1000	2.5kg (5.6lb)	2.6kg (5.7lb)	2.7kg (5.9lb)
1050	2.6kg (5.8lb)	2.7kg (6lb)	2.8kg (6.1lb)
1100	2.7kg (6lb)	2.8kg (6.2lb)	2.9kg (6.4lb)
1150	2.8kg (6.3lb)	2.9kg (6.5lb)	3kg (6.6lb)
1200	3kg (6.5lb)	3kg (6.7lb)	3.1kg (6.9lb)
1250	3.1kg (6.8lb)	3.1kg (6.9lb)	3.2kg (7.1lb)
1300	3.2kg (7lb)	3.3kg (7.2lb)	3.3kg (7.4lb)
1350	3.3kg (7.3lb)	3.4kg (7.4lb)	3.4kg (7.6lb)
1400	3.4kg (7.5lb)	3.5kg (7.7lb)	3.6kg (7.8lb)
1450	3.5kg (7.7lb)	3.6kg (7.9lb)	3.7kg (8.1lb)
1500	3.6kg (8lb)	3.7kg (8.2lb)	3.8kg (8.3lb)
1550	3.7kg (8.2lb)	3.8kg (8.4lb)	3.9kg (8.6lb)

Additional stroke lengths are available (up to 2470mm for S200D, up to 2435mm for S200T, and up to 2390mm for S200Q). Contact Nippon Pulse for more information.

## Forcer Spacing Distance

Spec	S200T	S200Q
Forcer Spacing Distance	14mm	
Pole (N/S) Distance	36mm	
Forcer Length	130mm	166mm
Flip Forcers	No	Yes

Tandem S200D forcers are possible, but are equivalent to one (1) S200Q forcer and thus are not listed above.

## Tandem Forcer



Forcer Spacing Distance

## Connector (Motor Cable)

Receptacle Housing	XMR-03V
Plug Housing	XMP-03V
Retainer	XMS-03V
Pin Contact	SXM-001T-P0.6
Socket Contact	SXA-001T-P0.6

To be installed by the user.

## Support and Bending

Stroke	Support Length (L2)	Max. Bending
0~300	25mm	0.00mm
301~700	40mm	0.30mm
701~1000	60mm	0.70mm
1001~max	60mm	0.90mm

Shaft Diameter (D) - 20mm ±0.2

Total Length (L)=Stroke (S)+Forcer Length (A)+(Support Length (L2)x2)

Note: Metric units guaranteed. Imperial (United States customary) units are calculated.

## THM Option

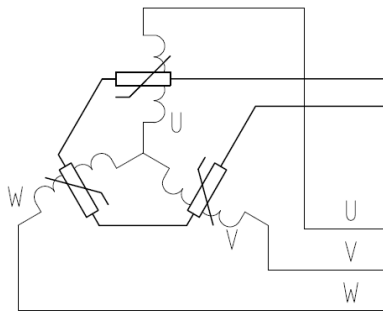

Circuit Diagram

### 4. Thermistor

PTCSL20T071DBE(Vishay)

## Thermocouple

Thermal sensor  
Thermocouple K type (marked each phase name)  
Attached to the surface of inside of coil  
Length 3000mm

Not all motors on this datasheet have received a CE Declaration of Conformity. Only the standard S200D, S200T and S200Q motors have been certified to CE standards. The motors and motor options with the following designations have not received a CE Declaration of Conformity, and as such are designated FGA: S200D-1S, S200T-1S, S200Q-2S, S200Q-1S, any S200 motor with Hall Effects, Thermistor or Thermocouple options.

---

For assistance in selecting the best motor for your application, contact Nippon Pulse  
to speak with an applications engineer. 1-540-633-1677

[www.nipponpulse.com](http://www.nipponpulse.com)